

****IMPORTANT NOTICE****

Both output terminals (labeled + and -) are ACTIVE. Neither terminal can be shorted to ground. Some subwoofers connect to the output terminals of the amplifier, and incorrectly assume the minus phase (-) terminal is grounded. Connecting Mimas in this way will cause damage to the amplifier, not covered under warranty. Consult the owner's manual for further information.



Vacuum tube installation procedure

IMPORTANT NOTICE

This Mimas is shipped with the vacuum tubes removed and packaged separately. The unit contains lethal voltages. Follow this procedure precisely to prevent electrical shock. Do not touch any electronic components, wire or other internal parts of the unit other than the vacuum tubes.

The tubes you have received should be labeled Vxy, where the x will represent a number, and the y will represent either "L" or "R". This designation indicates the correct location for that tube. The number part is indicated on the silk-screening on the printed circuit board, near the vacuum tube. The letter (L or R) indicates if it is for the left or right channel. If there is no L or R, then it can be used for either channel or is for a power supply.

To install the vacuum tube(s), follow the below procedure:

1. Turn off power to the unit.
2. Wait 15 minutes.
3. Disconnect power cord.
4. Take unit out of rack if necessary.
5. Remove top cover. There are 2 versions. Some units have 2 black Philips screws on the rear panel above the output connectors. If yours has these screws, first remove them. In either version, then grasp the rear lip of the cover panel and pull up.
6. Select the first tube to install.
7. Install new tube. Make sure it is firmly seated in the socket.
8. Following the same procedure, insert the remaining tube.
9. Replace top cover & reinstall the 2 screws that secure the cover to the chassis.
10. Reinstall unit if required.
11. Insert power cord. Turn on power.
12. Test unit.
13. Procedure complete.



Mimas Tube Placement

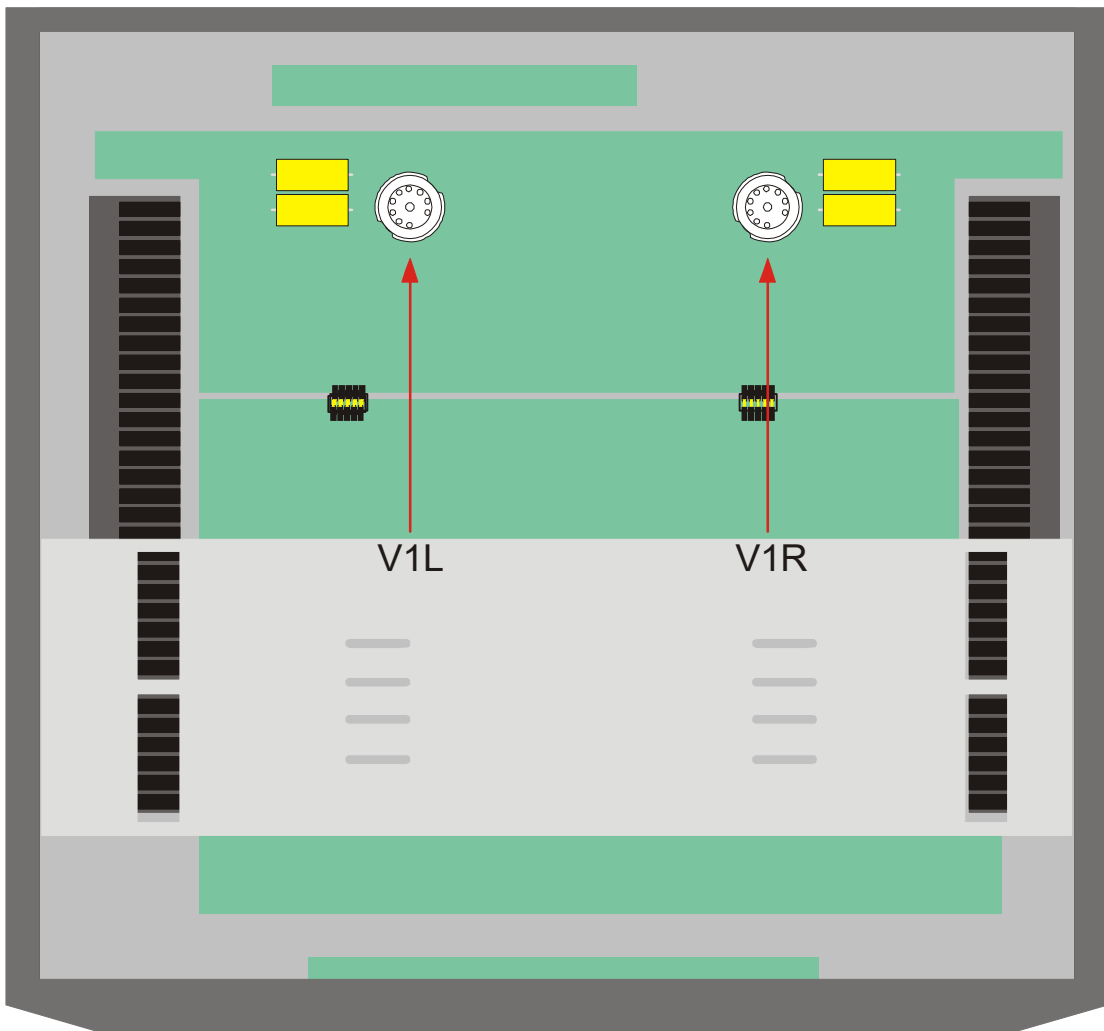

Front



M I M A S
Hybrid Integrated Amplifier

Owner's Manual

**PLEASE READ THIS DOCUMENT IN ITS ENTIRETY BEFORE USING
THE MIMAS.**

Aesthetix Audio Corporation
5220 Gabbert Rd., Suite A ♦ Moorpark, CA. 93021
Phone: (805) 529-9901

	CAUTION RISK OF ELECTRICAL SHOCK DO NOT OPEN	
CAUTION: TO REDUCE THE RISK OF ELECTRICAL SHOCK, DO NOT REMOVE COVER (OR BACK) NO USER-SERVICEABLE PARTS INSIDE REFER SERVICING TO QUALIFIED SERVICE PERSONNEL		

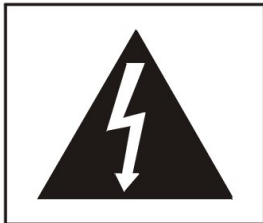

The lightning flash with arrowhead symbol, within an equilateral triangle, is intended to alert the user to the presence of un-insulated “dangerous voltage” within the product’s enclosure that may be of significant magnitude to constitute a risk of electric shock to persons.



The exclamation point within an equilateral triangle is intended to alert the user to the presence of important operating, maintenance (servicing) or other instructions in this manual and/or the literature accompanying the product.

WARNING

**TO REDUCE THE RISK OF FIRE OR ELECTRIC SHOCK,
DO NOT EXPOSE THIS PRODUCT TO RAIN OR MOISTURE**

CAUTION: TO PREVENT ELECTRIC SHOCK, DO NOT USE THE AC (POLARIZED) PLUG WITH AN EXTENSION CORD, RECEPTACLE OR OTHER OUTLET UNLESS THE BLADES CAN BE FULLY INSERTED TO PREVENT BLADE EXPOSURE.

Extension cords are not recommended for use with this product.

PREFACE

INTRODUCTION

Thank you for purchasing the Mimas Integrated amplifier. It has been engineered to deliver the highest attainable sound quality from your music sources. This is its sole purpose. Only the highest grade electronic components are used in the Mimas, including: non-inductive Roederstein metal film resistors in the signal path; polystyrene, polypropylene, and electrolytic power supply, bypass, and signal capacitors; low noise matched vacuum tubes; glass epoxy dual mono circuit boards; 16 gauge aluminum chassis; custom wound low flux power transformers.

PLACEMENT

The Mimas should be located away from possible sources of hum such as power cords, power transformers and the like. It should not be located near any other heat source such as another power amplifier or power supply. It must be kept well ventilated any time it is on. If it is positioned within an enclosed space then fans may be warranted. All air vents must remain unobstructed.

VENTILATION

When installing the Mimas in your system, make certain to allow a minimum of 4 inches of ventilation on each side of the unit. Also allow at least 6 inches of ventilation space above the unit. The front must be open.

BURN IN TIME

This unit has a break in period of about 400 hours during which continuous improvement in sound quality will be observed.

IMPORTANT

Save all packaging in a dry place away from fire hazards. Your Mimas is a precision electronic instrument and should be properly packaged any time shipment is made. In the unlikely event that you have to return your Mimas to the factory for service, or if you send it to us for updating, the original packaging will best protect the unit from shipping damage.

In order to achieve the fullest flexibility and enjoyment from your Mimas, we at Aesthetix recommend that you read this manual in full before connecting the unit to your audio system.

 **Note:** It is imperative that the Mimas be operated in a well-ventilated environment and the immediate external temperature be maintained as specified. External cooling fans may be required in some cases. Do not stack any equipment directly above or below the Mimas to protect it from overheating, as well as the continued functionality of any equipment near and around it.

 **Warning:** Each channel is a balanced bridged amplifier, thus the minus speaker terminal is **NOT** a ground, and cannot be connected to a system ground or a loudspeaker system with a common ground. Consult your speaker manufacturer to ensure that any speaker in your system that will be connected to the Mimas does **NOT** have internal circuitry with a common ground.

 **Warning:** **Before removing the top cover, the rear panel AC power switch MUST be turned off for at least 10 minutes so that the power supply can drain. Failure to do this will cause damage, not covered under warranty, to the Mimas. This applies in all cases and especially when installing / uninstalling a Phono and / or DAC module.**

WARNING

United States law prohibits disposition of these commodities to Libya, Laos, North Korea, Cambodia, Syria, Sudan or Cuba unless otherwise authorized by the United States.

AFTER MARKET and THIRD PARTY MODIFICATIONS

Please note that any aftermarket and/or third party modifications will void the warranty. In the case of changing the feet on a unit, in order to prevent any damage (which will also not be covered under warranty), please verify that the screws being used to secure non-Aesthetix feet do not screw any deeper into the chassis than the original ones. The original screw is 10-32 by 3/8" and extends into the chassis 1/8 inch.

Manual Conventions

For clarity purposes, a button/LED name will be in uppercase when instructed to press/view it, and capitalized when it is referred to. When any of the 5 line Inputs is referred to, INPx may be used, where x is 1, 2, 3, 4 or 5. Concurrently when editing an Input specific parameter in the Setup menu, SETA will be used for analog line inputs, SETP for phono inputs or SETD for digital inputs.

SAFETY PRECAUTIONS



Please carefully read each item of the operating instructions and safety precautions before installing and using this product. Use extra care to follow the warnings written on the product itself and/or in the operating instructions. Keep the operating instructions and safety precautions for future reference.

CAUTION: TO REDUCE THE RISK OF ELECTRICAL SHOCK, DO NOT REMOVE ANY OF THE COVER PANELS.

NO USER-SERVICEABLE PARTS INSIDE. REFER ALL SERVICING TO QUALIFIED SERVICE PERSONNEL ONLY.

TO PREVENT FIRE OR SHOCK HAZARD, DO NOT ALLOW LIQUIDS TO SPILL OR OBJECTS TO FALL INTO ANY OPENINGS OF THE PRODUCT.

THIS UNIT IS SUPPLIED WITH A 3 PIN GROUNDED AC PLUG. ALWAYS INSERT THE AC PLUG INTO A GROUNDED OUTLET. DO NOT REMOVE THE GROUND PIN OR DISABLE THE GROUND FOR ANY PURPOSE.

BEFORE MAKING ANY CONNECTIONS TO THE MIMAS, FIRST TURN OFF THE POWER AND THEN DISCONNECT THE AC POWER CORD.

WHEN INSTALLING THE MIMAS IN YOUR SYSTEM, MAKE CERTAIN TO ALLOW A MINIMUM OF 4 INCHES OF VENTILATION ON EACH SIDE OF THE UNIT. ALSO ALLOW AT LEAST 6 INCHES OF VENTILATION SPACE ABOVE THE UNIT. IMPROPER VENTILATION OF THE UNIT MAY CAUSE OVERHEATING, WHICH MAY DAMAGE THE UNIT AND CAUSE A FIRE. PLACE THE UNIT ON A SOLID SURFACE ONLY. I.E. NOT ON CARPET, ETC.

DO NOT PLACE THE MIMAS NEAR HEAT SOURCES SUCH AS DIRECT SUNLIGHT, STOVES, HEAT REGISTERS, RADIATORS OR OTHER HEAT PRODUCING EQUIPMENT.

TO PREVENT DAMAGE TO THE ANALOG OUTPUT CIRCUITRY, BE CERTAIN NOT TO SHORT THE OUTPUT SIGNAL TO GROUND. ENSURE THAT YOUR AUDIO OUTPUT CABLES DO NOT HAVE ANY INTERNAL SHORTS BEFORE CONNECTING THEM TO THE MIMAS.

IF REPLACEMENT OF THE AC LINE FUSE AND/OR ANY INTERNAL FUSE BECOMES NECESSARY, REPLACE ONLY WITH SAME VALUE AND TYPE OF FUSE. NEVER BYPASS THE FUSE.

IF THE AC CORD BECOMES DAMAGED, DO NOT USE IT. IMMEDIATELY REPLACE IT WITH A NEW ONE OF THE SAME OR BETTER RATING.

IT IS IMPERATIVE THAT THE MIMAS BE OPERATED IN A WELL VENTILATED ENVIRONMENT AND THE IMMEDIATE EXTERNAL TEMPERATURE BE MAINTAINED AS SPECIFIED. EXTERNAL COOLING FANS MAY BE REQUIRED IN SOME CASES. DO NOT STACK ANY EQUIPMENT DIRECTLY ABOVE OR BELOW THE MIMAS AS TO PROTECT IT FROM OVERHEATING, AS WELL AS THE CONTINUED FUNCTIONALITY OF ANY EQUIPMENT NEAR AND AROUND IT.

EACH CHANNEL IS A BALANCED BRIDGED AMPLIFIER, THUS THE MINUS SPEAKER TERMINAL IS NOT A GROUND, AND CANNOT BE CONNECTED TO A SYSTEM GROUND OR LOUDSPEAKER SYSTEM WITH A COMMON GROUND. CONSULT YOUR SPEAKER MANUFACTURER TO ENSURE THAT ANY SPEAKER IN YOUR SYSTEM THAT WILL BE CONNECTED TO THE MIMAS DOES NOT HAVE INTERNAL CIRCUITRY WITH A COMMON GROUND.

IF THE TOP COVER HAS TO BE REMOVED, FIRST TURN OFF THE REAR PANEL POWER SWITCH AND WAIT 10 MINUTES. THEN REMOVE THE TWO 6-32 PANHEAD SCREWS AT THE TOP OF THE REAR PANEL AND LIFT THE BACK OF THE TOP COVER UPWARDS. FAILURE TO DO THIS WILL RESULT IN DAMAGE, NOT COVERED UNDER WARRANTY, TO THE MIMAS.

Table Of Contents

PREFACE	3
INTRODUCTION.....	3
PLACEMENT	3
VENTILATION.....	3
BURN IN TIME.....	3
IMPORTANT	3
WARNING.....	3
SAFETY PRECAUTIONS.....	4
Front Panel Layout.....	6
Rear Panel Layout	7
Wiring Diagram	8
AC Power:.....	8
Initial Unit Setup.....	9
Standby	9
Remote Trigger	9
Menu Map.....	10
OPERATION.....	11
Main Menu.....	11
Input Select.....	11
Display	11
Mute.....	11
Volume.....	11
Setup	12
Setup General.....	12
Headphones.....	13
Balance	13
Start Level	13
Maximum Level.....	13
IR (Infrared).....	13
Display (Advanced Display Functionality)	14
Restore (Factory Settings)	14
Setup Input	15
Input On/Off	15
Input Level.....	15
Home Theater Bypass	15
Input Name	16
Bypass (Advanced).....	16
Internal Gain Setting.....	16
RS232	16
Phono	17
Setup Phono	18
Cartridge Type	18
Resistive Load.....	18
Capacitive Load	18
Gain.....	18
Input Active	18
Phono Input Name	18
Digital to Analog Converter (DAC)	19
Setup DAC.....	20
Input Active	20
Level.....	20
Digital Input Name.....	20
Advanced (USB / D1 Input Only)	20
Appendix A Internal Gain Jumper Settings.....	21
Appendix B Troubleshooting & Maintenance Guide.....	22
Display Codes	22
Maintenance.....	22
Appendix C RS232 Pinout	23
Appendix D Specifications	24
Appendix E Warranty.....	25

Front Panel Layout

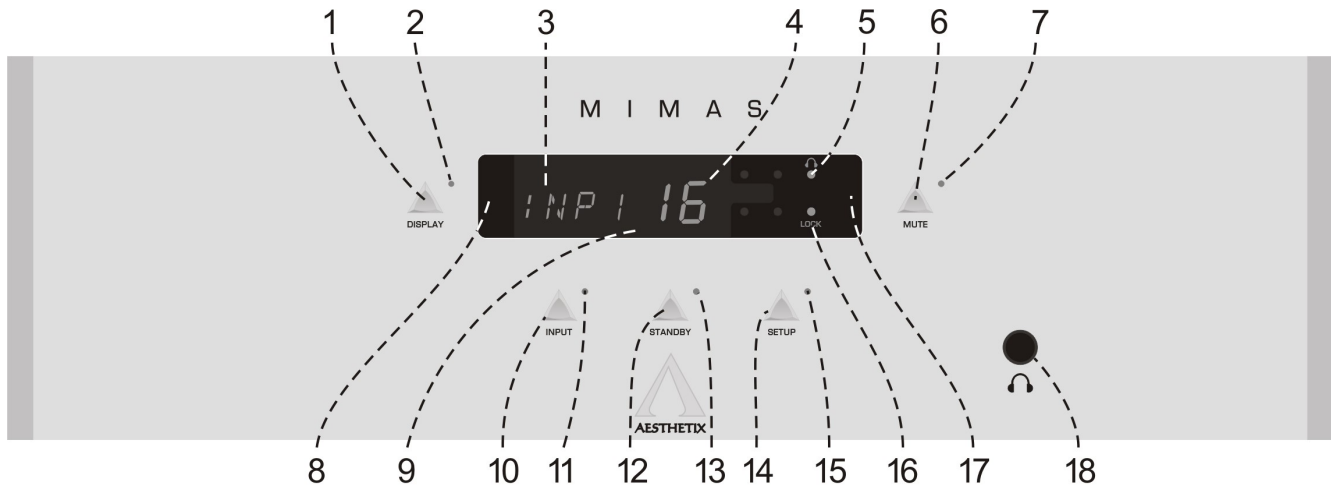

Figure 1 - Front Panel Layout

1. **DISPLAY** button. Press to extinguish or illuminate the display. This button is also used in some Setup menus.
2. Display **LED**. Not used in normal operation. It is illuminated in some Setup menus, indicating that the Display button is used for editing the currently selected parameter.
3. In the Main menu, the four left characters are the name of the currently selected input.
4. In the Main menu, the larger, two rightmost numbers represent the current volume level, or BP if the selected input is set to Bypass.
5. Headphone **LED**. Illuminates when the output signal is routed to the headphone jack only.
6. **MUTE** button. Toggle to mute or un-mute the Mimas.
7. Mute **LED**. Illuminates when the Mute function is active.
8. Pressing the left side of the **DISPLAY** will lower the volume, or decrement the value when in a sub-menu.
9. LED **DISPLAY**.
10. **INPUT** button. Used to scroll through Inputs. Also used in some Setup menus to scroll through parameter selections.
11. INPUT **LED**. Illuminates when the MAIN menu is active or when the Input button (Enter button on the remote) can be used to scroll through any of the Setup menus.
12. **STANDBY** button. After the rear panel **MAIN POWER** switch is turned on and the Mimas has completed its Warm Up cycle, press the front panel **STANDBY** button to exit the standby mode. Pressing this button again will put the Mimas into **STANDBY** and illuminate the Standby **LED**. Place Mimas in standby when not in use.
13. Standby **LED**. Illuminates when the Mimas is in Standby, flashes when coming out of Standby, off when the Mimas is in operational mode.
14. **SETUP** button. Accesses all setup menus. Press to exit the Setup Menu system.
15. Setup **LED**. It is illuminated when in any of the Setup menus.
16. LOCK **LED**. Illuminates when the Mimas locks onto a digital input signal.
17. Pressing the right side of the **DISPLAY** will raise the volume, or increment a value when in a Setup menu.
18. **HEADPHONE** jack. When enabled, the output signal is re-routed from the main outputs, to the headphones.

Rear Panel Layout

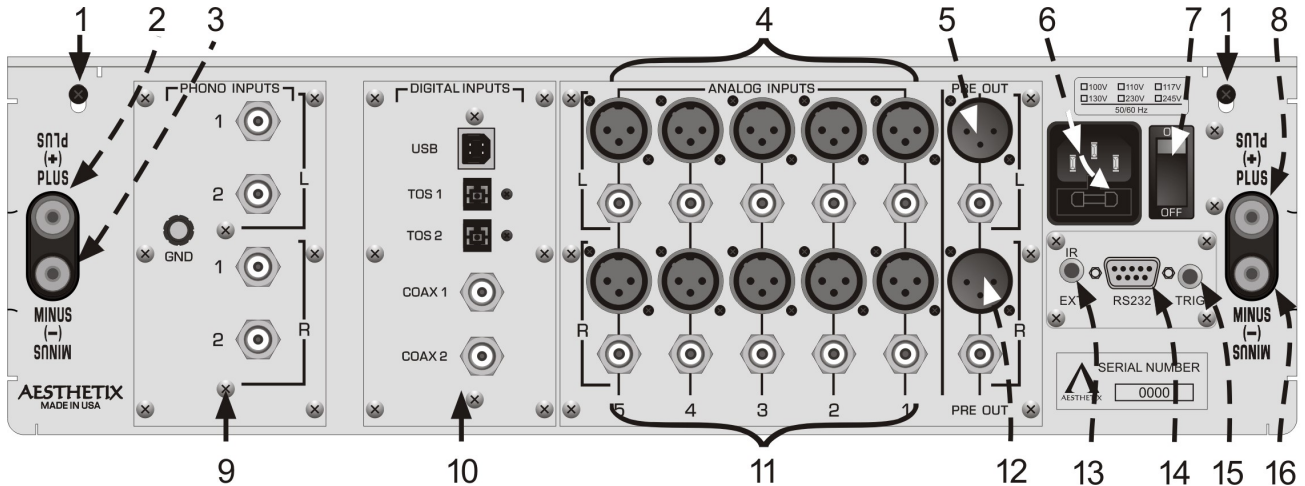

Figure 2 - Rear Panel Layout

1. 6-32 screws to secure the top cover. Before removing top cover, turn off rear panel **MAIN POWER** switch and wait 15 minutes. Then remove the two 6-32 screws and pull up top cover from the rear panel. **Not waiting at least the minimum specified time can cause damage, not covered under warranty, to the Mimas.**
2. Right channel Plus **BINDING POST**. Connect plus speaker wire for the right speaker to this terminal.
3. Right channel Minus **BINDING POST**. Connect minus speaker wire for the right speaker to this terminal. DO NOT CONNECT TO GROUND.
4. Left channel balanced and single-ended Analog Input jacks.
5. Left channel balanced and single-ended Preamp Output.
6. **AC POWER INPUT** and main fuse. Spare fuse inside.
7. **MAIN POWER Switch**. Disconnects AC to all circuits. It is recommended that this be left ON at all times during regular use with the exception of whenever cables are connected/disconnected or when the unit is not going to be used for an extended period of time.
8. Left channel Plus **BINDING POST**. Connect the plus speaker wire for the left speaker to this terminal.
9. Optional Phono Input module.
10. Optional Digital to Audio (DAC) input module.
11. Right channel balanced and single-ended Analog Input jacks.
12. Right channel balanced and single-ended Preamp Output.
13. IR extender input jack. Connect external IR receiver to this input
14. DB9 **RS232** connector. Used for connecting a system control device to the Mimas to control and monitor its functions.
15. Remote Trigger jack. If the rear panel trigger jack receives a 5-12VDC signal, the Mimas will come out of standby if the Main Power switch is in the On position.
16. Left channel Minus **BINDING POST**. Connect the minus speaker wire for the left speaker to this terminal. DO NOT CONNECT TO GROUND.

Wiring Diagram

----- = Optional connection

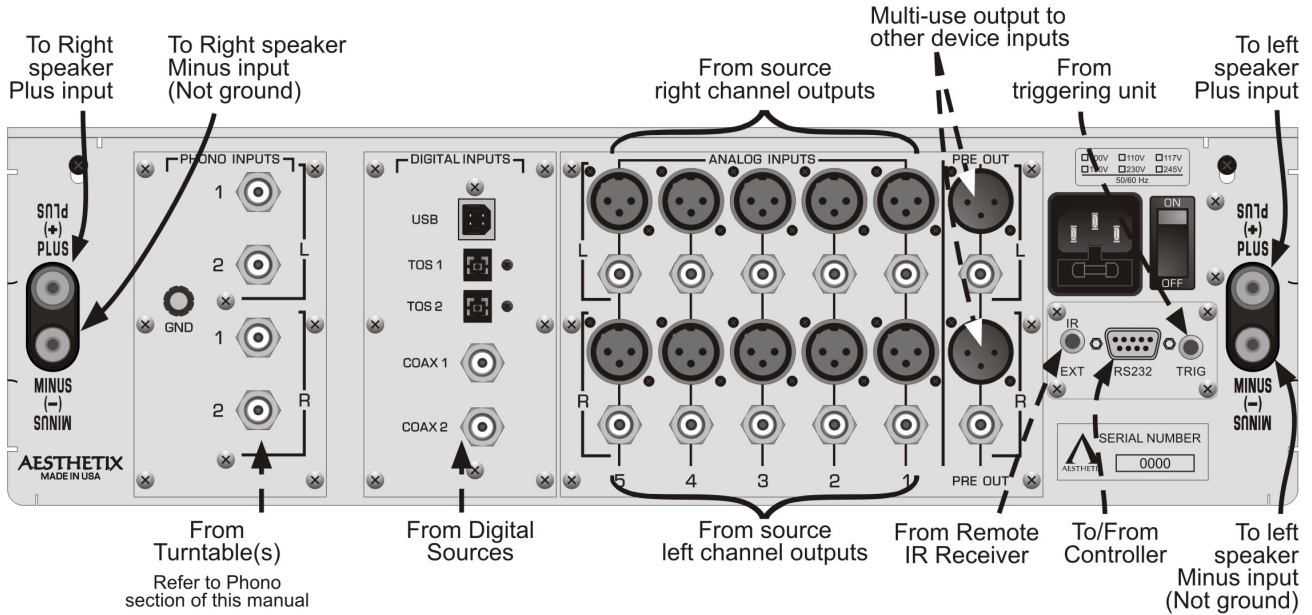

Figure 3 - Examples of Typical Input and Output Connections

CAUTION: Make all input and output connections before turning the Mimas Main Power Switch on.

WARNING! The Mimas rear panel Main Power switch **MUST** always be turned **OFF** when making or changing speaker connections.

AC Power:

The Mimas may be plugged directly into an un-switched wall outlet. Although proprietary RFI (radio-frequency interference) filtering is built into the Mimas, in some situations an AC power-line filter may provide additional sonic benefits. A power-line conditioner with spike and brownout features is recommended.

Initial Unit Setup



With the AC cord disconnected, remove the Mimas top cover by first removing the two Philips screws on the rear panel closest to the top, then lift each rear corner one at a time.

Install 2 tubes into the Mimas. See Mimas Tube Guide. Afterwards replace the top cover and secure it with the same 2 Philips screws.

Connect all sources to the Mimas rear panel inputs.

If used, connect a trigger cable to the device that the Mimas standby will either control, or be controlled by. Refer to “Remote Trigger” section below.

Connect a third party IR extender, if desired.

Connect the speakers to the Mimas outputs. Please adhere to all warnings and references in this documentation with regards to not connecting the Mimas speaker minus (-) terminal to any ground.

Connect the AC cord.

Turn on the rear panel power switch. If the optional Phono module is installed, the display will read PONO, then INST. If the optional DAC module is installed, the display will read DAC, then INST. Each time the rear panel power switch is turned on, the Mimas will go into Warm Up mode for up to 2 minutes. The timing of this is dependent on the current temperature of the Output module heatsinks. During this time the display will read **WARM UP**.

Note: If using the optional HRC-3 hand held remote, it is shipped in “Transport” mode (off). It must first be set to Active. Please refer to the HRC-3 remote owner’s manual.

Install battery(s) in the hand held remote control.



CAUTION! To avoid loud pops and possible speaker damage, turn on all other system components before taking the Mimas out of standby.

Standby

After the Mimas completes its Warm up phase, it will then go into Standby and the Standby LED will illuminate. Pressing the STANDBY button will initiate the startup process. At this time the blue Standby LED will blink for a few minutes before displaying the Main Menu. Place Mimas in standby when not in use. All edits are permanently stored when going into standby. To avoid losing edits, make sure to put the Mimas in standby prior to turning off the rear panel AC power.

Remote Trigger

The remote trigger control allows an external component to control the STANDBY state of the Mimas. Connect the Trigger Out jack from a host component to the Remote Trigger input jack on the rear panel of the Mimas.

The trigger voltage should be between +5 and +12 volts DC. There are two signal types that may be used; level and pulse. The Mimas automatically senses which type of trigger signal it is receiving and responds accordingly.

A positive pulse that is greater than 100mS is interpreted as a Level trigger whereas shorter pulses are treated as Pulse triggers. The minimum detectable pulse is 50uS.

When a Level type signal is received, the Mimas will be taken out of standby and when that signal drops to zero, the Mimas will go into standby.

When a positive pulse signal is received, the Mimas will toggle between STANDBY and OPERATE modes, duplicating the action of the front panel STANDBY button.

Use a 1/8” (3.5mm) mono plug for this jack. The tip is positive and the sleeve is ground.

Menu Map

Main Menu



Note: When using the HRC-3 remote, use the Enter button instead of pressing INPUT

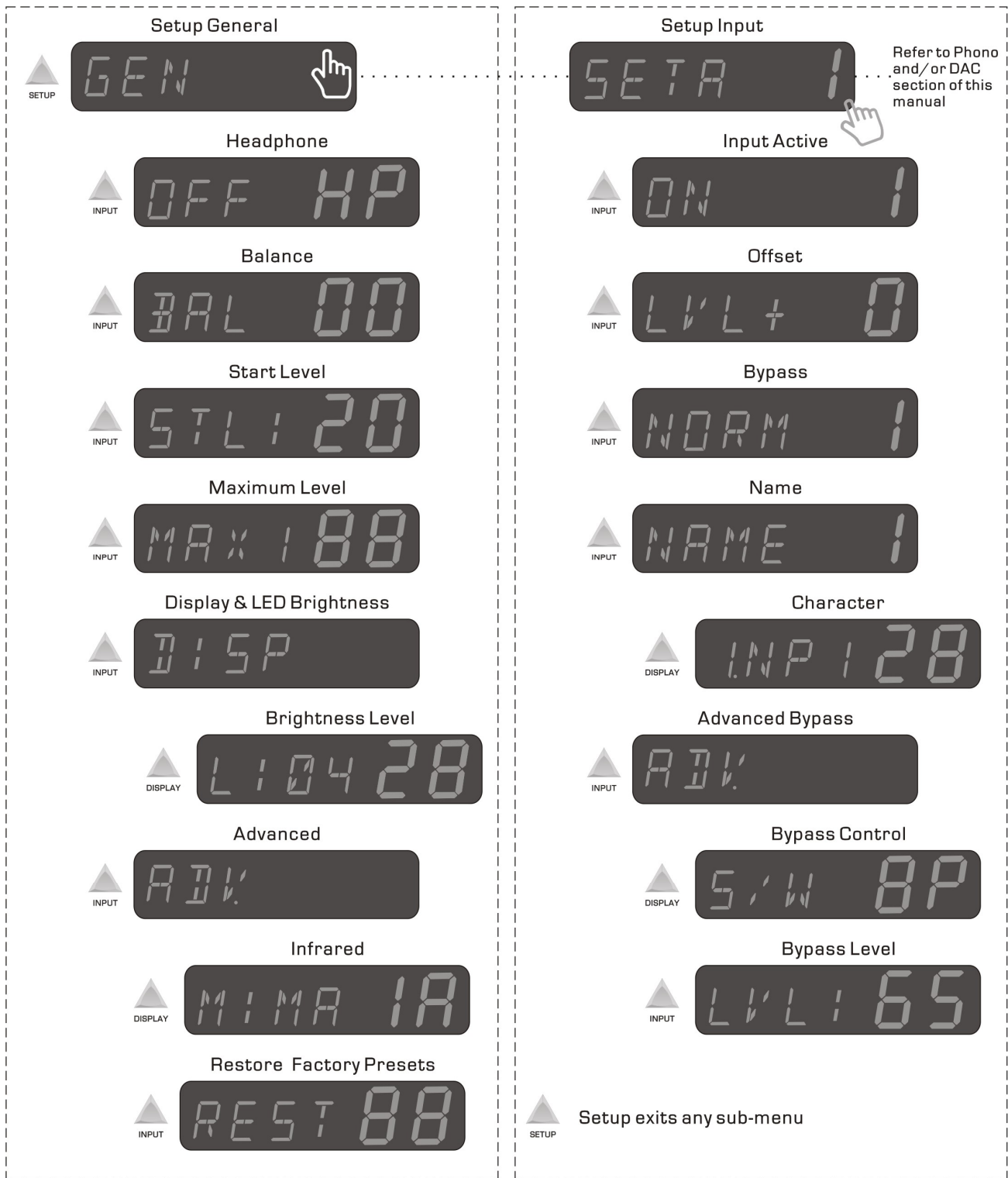

Pertains to software version 1.79. Other versions may vary.

Rev.S3.03 2020-01-30

Figure 4 – Mimas Standard Menus

OPERATION

Note: Put the Mimas into Standby before turning off the rear panel AC Power Switch.

It is normal that a slight pop may be heard when going into or coming out of Standby. This is due to the amplifier switching from high bias to low bias.



Important Note: In order to extend the life of the tubes, do not have a source playing into the Mimas while it is in **STANDBY**. Mute the source first.

Main Menu

When the Mimas comes out of standby, it will be muted and the Main Menu will be displayed. The Main Menu consists of the currently selected input and the master volume level. If the currently selected input is in Bypass mode, BP will be displayed instead of the volume level. Place Mimas in standby when not in use. All edits are permanently stored when going into standby. To avoid losing edits, make sure to put the Mimas in standby prior to turning off the rear panel AC power.

Pressing the left or right side of the Display lens (UP/DOWN on the remote) will raise or lower the volume when not in Bypass.

Input Select

Repeatedly pressing the front panel or remote INPUT button advances the currently selected input to the next. The factory default Line input names are INPx, where x is 1 through 5 – corresponding to the rear panel input jack labeling. The factory default phono input names are P1 and P2 and D1-5 for the digital Input names.

Display

When the DISPLAY button is pressed, all LEDs will extinguish. Pressing any button will turn on the display and applicable indicator LEDs. If the button pressed was INPUT or MUTE, the display and LEDs will extinguish again after 5 seconds. If the STANDBY button was pressed, the unit will immediately enter the Standby mode. In Standby, the Standby LED is always illuminated, regardless of whether the display was on or off. Pressing the DISPLAY button while the display is off, or during the 5 second timeout period, will turn on the display and normal operation will return.

Note: The LED for the DISPLAY button is intentionally inactive unless in a Setup menu, where it may be used to indicate that the Display button is used to select a submenu.

Mute

Pressing the MUTE button will alternately mute or un-mute the unit. When the Mute LED is illuminated, there will be no audio at the speaker outputs. The Mute feature is available in most Setup menus.

Volume

The volume can be raised or lowered by pressing the left or right side of the front panel display, or the UP and DOWN buttons on the remote.

Setup

The SETUP button accesses a set of features that are programmable for each individual Input, and another set of features that are 'Global', or General. Pressing the Setup button once accesses the General (GEN) sub menu. Pressing the right side of the display lens (Right arrow on the remote) takes the user to the (SETAx) settings by input, beginning with Input 1 (SETA1). Each time the Setup submenu is accessed, the last used (GEN or SETx) Setup type will display first. Each time the Mimas comes out of Standby, the default Setup type first displayed will be GEN.

When in any Setup menu, pressing the SETUP button once will exit and return the user to the Main Menu.

Note: To audition changes in the Setup submenus, the user must re-select the edited input. This does not apply to the Input Level (Offset), Balance and Headphone features, where edits are audible in real time with each parameter change.



Important Note: When edits are made, the changes are stored in a temporary memory area. They are permanently stored when the Mimas is put into Standby.

Setup General

The General setup options are:

- Enabling/disabling the Headphone jack.
- Shifting the Left/Right Balance.
- Creating a [volume] Start Level when the Mimas comes out of standby.
- Setting a maximum level that the Mimas can be turned up to (Child proofing, speaker protection and neighbor compatibility).
- Setting up the front panel display and LED brightness options.
- Set the Mimas front panel IR receiver to respond to command sets from either the Mimas or Aesthetix Calypso HRC-2 remote control.
- Restoration of factory presets.

At any time that a sub menu is displayed, pressing the INPUT button will advance to the next parameter. Pressing the left and/or right side of the front panel lens will edit the displayed parameter value. The Mute feature is active in all of these submenus with the exception of Restore Defaults.

Headphones

By default the Headphone feature is set to OFF. The Mimas will auto sense when headphones are plugged in and the display will indicate that the Headphone (HP) jack is enabled (ON). This will disable the speaker outputs. When the headphones are unplugged, the Mimas will disable the Headphone jack and enable the speaker outputs.

Caution is to be given to note the Master Volume level prior to unplugging headphones.

The Headphone jack setting can be changed while headphones are plugged in. This is useful when the user wishes to leave the headphones connected and go back and forth between listening to the speakers or the headphones.

To enable or disable the Headphone jack, first press the SETUP button. If the menu does not say GEN, repeatedly press the right side of the display (Right arrow on the remote) until it does. Press the INPUT button (Enter on the remote). The display will read **OFF HP** or **ON HP**. Toggle this parameter by pressing the left/right side of the display or the UP/DOWN buttons on the remote. Press the SETUP button to exit, or the INPUT button (Enter on the remote) to access additional programmable features.



Caution!! It is important to note that any time the headphones are unplugged from the front panel, the speakers will automatically be enabled. Please note the Master Volume level prior to disconnecting the headphones.

Balance

The Balance can be shifted 12dB to the left or right. Going past that turns the opposite speaker off.

To access this menu, press the SETUP button. If the menu does not show GEN, repeatedly press the right side of the display (Right arrow on the remote) until it does. Press the INPUT button (Enter on the remote) two times to display **BAL 00**. Press the volume UP or DOWN button on the remote, or the right/left side of the front panel lens to set the desired Balance. Press the SETUP button to return to the Main menu.

Start Level

The factory default is 0 and the programmable range is 0-40.

To set the volume level that the Mimas will be at when coming out of Standby, press the SETUP button. If the menu does not show GEN, repeatedly press the right side of the display (Right arrow on the remote) until it does. Press the INPUT button (Enter on the remote) three times to display **STL XX**. Press the volume UP button on the remote or the right side of the front panel lens to set the desired level. Press the SETUP button to return to the Main menu.

Maximum Level

The factory default is 88 and the programmable range is 50-88.

To set the maximum volume level that the Mimas will go to, press the SETUP button. If the menu does not show GEN, repeatedly press the right side of the display (Right arrow on the remote) until it does. Press the INPUT button (Enter button on the remote) four times to display **MAX: XX**. Press the volume down button on the remote or the left side of the front panel lens to set the desired level. Press the SETUP button to return to the Main menu.

IR (Infrared)

The factory default is Mima[s].

To set whether the Mimas responds to a Mimas or Calypso remote, from the Main menu, press the SETUP button and if the menu does not show **GEN**, repeatedly press the right side of the display lens (Right arrow on the remote) until it does. Now press the INPUT button (Enter on the remote) 6 times so that the display reads **ADV**. (Advanced). The LED next to the DISPLAY button will illuminate, indicating that this button is now active. Press the DISPLAY button once. The display will read **MIMA IR**. Press the volume UP or DOWN button on the remote or either side of the front panel lens to select the desired response. Press the SETUP button to return to the Main menu.

Display (Advanced Display Functionality)

The Mimas is able to sense the ambient light level in the room and adjust its front panel LED brightness accordingly. While the factory settings will work for most situations, there may be times when adjustment to the settings is useful.

The Mimas will read the current ambient room brightness and break it down onto 16 levels (00-15), where 00 is a very dark room and 15 is a very bright room, as measured at the center of the front panel display lens. As the room brightness changes, the Mimas will read it and set the brightness of the display according to the user's desire. The factory presets will bring the LED brightness down as the room darkens. This low LED brightness level will be difficult to read or completely washed out then the room brightens, so as this happens, the LED brightness increases.

Should it be desired to edit these settings, from the main menu, press the SETUP button and if the menu does not show GEN, repeatedly press the right side of the display (Right arrow on the remote) until it does. Press the INPUT button (Enter on the remote) six times to display **DISP**. Note that the Display button LED illuminates, indicating that pressing the DISPLAY button will access the Display brightness Setup submenu. Once the DISPLAY button is pressed, **L104 XX** will appear in the display.

In this example, L1 refers to Light Level 1. 04 is the current ambient light level the Mimas is reading in the room. XX is the value the user can change the display brightness to when the Mimas reads the room light level at 1. As the desired value is edited, the display brightness changes to show the user how bright or dim the current setting will be.

Note: If edited via the front panel, the user's hand or body could shadow the path of the ambient room light level that the Mimas light sensor reads. Therefore it is recommended to view/edit this feature via the hand held remote.

Restore (Factory Settings)

The Restore feature restores the factory settings for all programmable parameters.

From the Main menu, press the SETUP button and if the menu does not show **GEN**, repeatedly press the right side of the display lens (Right arrow on the remote) until it does. Now press the INPUT button (Enter on the remote) 6 times so that the display reads **ADV**. (Advanced). The LED next to the DISPLAY button will illuminate, indicating that this button is now active. Press the DISPLAY button once, and then press the INPUT button Enter on the remote). The display will read **REST**. Press the right side of the Display lens (Up arrow on the remote) twice so that it reads **YES**, and then press the DISPLAY button. The Display will flash 3 times, indicating that the factory settings have been restored. Note: when the display reads **NO**, pressing any button will have no effect on the current settings. This option will allow the user to abort by pressing the INPUT or SETUP button.



Caution!! After restoring the factory defaults, the Mimas will re-start.

Setup Input

The individual Input Setup options are:

- Enable/Disable the currently selected Input.
- Adjusting the input level to match that of other inputs.
- Selecting an Input(s) to be used for Home Theater Bypass.
- Naming an enabled Input.
- Selecting advanced Home Theater Bypass options.

At any time that a sub menu is displayed, pressing the Input button (Enter on the remote) will advance to the next parameter. Pressing the left and/or right side of the front panel lens (UP/DOWN buttons on the remote) will edit the displayed parameter value. When Naming an Input or setting advanced Home Theater bypass options, the DISPLAY button is used to enter these sub menus first. In these cases, the Display LED will be illuminated. In all sub menus except NAME, the Mute feature is active.

The factory settings for each Line Input Name are Inp1, 2, 3, 4 or 5, TT 1, TT 2 for the two Phono Inputs and D1-5 for the 5 Digital Inputs. The instructions in this section will edit Inp1.

Note: When editing Input specific parameters, the name of the Line input to be edited will be SETA1, 2, 3, 4 or 5. The Phono Inputs will be P1 and P2, and D1-5 for the Digital Inputs.

* * *

Input On/Off

The factory default setting for each Input is ON.

From the Main menu, to set whether an Input is active or not, press the SETUP button. Press the left or right side of the Display (UP/DOWN buttons on the remote) to select SETAx, where x = the Line input to be edited. In this example, SETA1. Press the INPUT button (Enter on the remote) once. Press the left or right side of the Display (UP/DOWN buttons on the remote) to turn the Input On or Off. Press the SETUP button to exit and return to the Main menu.

Input Level

The factory default is 0.

Line level sources may have different output levels. To streamline this, the Mimas allows the user to adjust any Input level to match that of other sources. The range is -12 to + 12.

To change the offset of Input 1, from the Main menu press the SETUP button. Press the left or right side of the Display (Left/Right arrow on the remote) to select SET1. Press the INPUT button (Enter on the remote) twice so that the display reads **LVL**. Use the left or right side of the Display (UP/DOWN buttons on the remote) to select the desired value. If the source is playing, the user will hear the audio level change as the displayed value does. Press the SETUP button to exit and return to the Main menu.

Home Theater Bypass

The factory default is OFF. On the Main menu, a Bypassed input will be displayed as **INPx BP**, and volume & mute changes are disabled, as the source device will control these features.

From the Main menu, to enable or disable Bypass for Input1, press the SETUP button. Press the left or right side of the Display (Left/Right arrow on the remote) to select SET1. Press the INPUT button (Enter on the remote) three times so that the display reads **NORM** or **BYP**. Use the left or right side of the Display (UP/DOWN buttons on the remote) to select the desired value. Press the SETUP button to exit and return to the Main menu. Refer to *Bypass (Advanced)* on the next page for additional bypass options.

Input Name

The factory default names for Analog Line inputs are INP1 through INP5, TT1 & TT2 for the Phono Inputs and USB, TOS1, TOS2, Cox1 & Cox 2 for the Digital Inputs (when installed).

Each input can be named using up to four characters. The available characters are A-Z; [blank]; 0-9 and several special characters.

To name an Input, from the Main menu press the SETUP button. Press the left or right side of the display lens (Left/Right arrow on the remote) to select SETA 1, or the desired Input to name. Press the INPUT button (Enter on the remote) four times so that the display reads NAME. Press the DISPLAY button once. The current name is displayed. Use the left or right side of the display lens (or Up/Down button on the remote) to select the desired character. Press the DISPLAY button to move to the next character, which is identified with a dot to the right of it. Repeat to edit each character. Press the SETUP button to exit and return to the Main menu.

Bypass (Advanced)

When an Input is set to Bypass mode, the signal path is the same as when it is not, however the volume is a fixed level. The factory default level is 65. (If internal jumpers are in the Low Gain position, unity gain would be 80). If needed, the fixed gain value can be adjusted.

Note: The Input must be set to BYP (see the *Home Theater Bypass* section on previous page) for this parameter to have an effect.

To set this up from the Main menu, press the SETUP button once, then press the left or right side of the display lens (UP/DOWN buttons on the remote) to select SETA x, where x is the desired bypassed input. Press the INPUT button (Enter on the remote) five times so that the display reads **ADV**. Press the DISPLAY button, followed by the INPUT button (Enter on the remote) and then use the left/right side of the display lens (Up/Down on the remote) to select the desired Bypass fixed level. Press the SETUP button to exit and return to the Main menu.

* * *

Internal Gain Setting

There are gain shunts (2 per channel) that allow the internal gain to be set at 0 or -15dB. Changes to these settings must be completed by an authorized service technician, and the unit must have its AC cord removed for at least 15 minutes prior to removing the top cover. Contact your dealer if these settings need to be adjusted. The shunt positions are detailed in Appendix A.

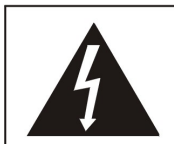

Caution: to reduce the risk of electrical shock, do not remove any of the cover panels.

No user-serviceable parts inside. Refer all servicing to qualified service personnel only.

RS232

All functions of the Mimas can be controlled and monitored via RS232, using the DB9 connector. As long as the rear panel power switch is turned on, the RS232 circuitry is always active, thus allowing the Mimas to be taken out of **STANDBY** via RS232. Refer to Appendix D for more information on using RS232.

Phono

When the optional Phono input module is installed, additional submenus will be revealed in the *Setup Input* section. The Phono submenus are shown below in the right-hand column.

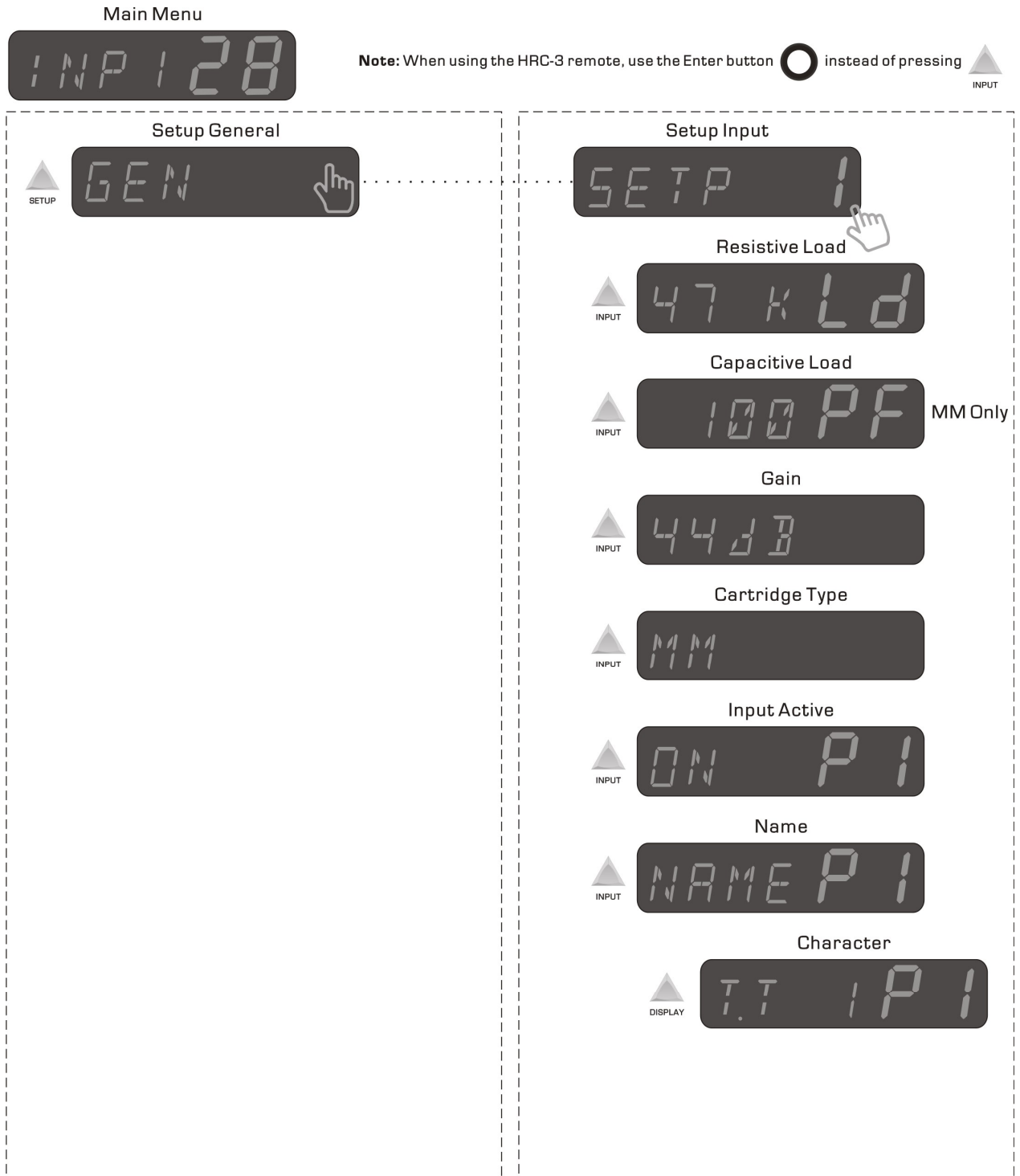

Pertains to software version 1.70. Other versions may vary.

Rev. P3.00 2019-03-07

Figure 5 – Mimas Phono Menu Map



As indicated above, the Capacitive Loading submenu is available only when the Cartridge Type is set to MM. Therefore if the cartridge being used is a moving magnet, begin by setting the Cartridge Type to MM. The factory default is MC.

Setup Phono

There are two phono inputs on the Phono Module, both offering a single-ended RCA input connector. In the Setup Phono submenus, the first is referred to as P1 and the second as P2. Both can store unique settings for different cartridges.

To set the Phono inputs to their appropriate values, navigate to the Phono Setup submenu by pressing the SETUP button, then press the right side of the display lens to get to the Setup *Input* menu. Continue pressing the right side of the lens until the desired phono input (P1 or P2) is displayed.

Cartridge Type

As indicated on the previous page, if the cartridge type being used for the currently selected phono input is a Moving Magnet, press the INPUT button 4 times to display the Cartridge Type submenu and press the lens Left or Right to change the type to MM.

Resistive Load

From Setup/Input/Phono, press the INPUT button once. The Resistive Load sub-menu will be displayed.

If the Cartridge Type is set to MC (default), the available Load values will be: 47K, 20K, 10K, 5K, 2.5K, 1K, 750 ohms, 500, 375, 250, 200, 150, 125, 100 and 75 ohms.

If the Cartridge Type is set to MM, the available Load values will be 47K, 20K, 10K and 5K ohms.

The correct loading will be achieved when music has the right balance of dynamics, high frequency extension and lack of glare or brightness. Generally speaking, less loading (higher ohms) results in more high frequencies and more dynamics but can be too bright for some cartridges. More loading (lower ohms) can reduce brightness but if overdone can result in reduced dynamics and a dull, lifeless quality. Consult your dealer for loading recommendations on the cartridge(s) you are using.

Capacitive Load

Only when the Cartridge Type is set to MM will this sub-menu appear. The available options are: 100pF, 220pF, 330pF and 470pF.

Gain

If the Cartridge Type is set to MC, the available Gain values will be: 72, 68, 64 and 60dB.

If the Cartridge Type is set to MM, the available Gain values will be: 56, 52, 48 and 44dB.

Input Active

The factory default setting for Phono1 Input is ON, whereas Phono 2 is OFF.

From the Main menu, to set whether an Input is active or not, press the SETUP button. Press the left or right side of the display lens (UP/DOWN buttons on the remote) to select SETPx, where x = the input number to be edited. In this example, P1. Press the INPUT button (Enter on the remote) 5 times. Press the left or right side of the display lens (UP/DOWN buttons on the remote) to turn the Input On or Off. Press the SETUP button to exit and return to the Main menu.

Phono Input Name

The factory default Phono Input Names are TT 1 and TT 2.

Both phono inputs can be named using up to four characters. The available characters are A-Z; [blank]; 0-9 as well as several special characters.

To name a phono input, from the Main menu press the SETUP button. Press the left or right side of the display lens to select SETP 1 or SETP 2. Press the INPUT button (Enter on the remote) six times so that the display reads the current name. Press the DISPLAY button once. Use the left or right side of the display lens (or UP/DOWN buttons on the remote) to select the desired character. Press the DISPLAY button to move to the next character, which is identified with a dot to the right of it. Repeat to edit each character. Press the SETUP button to exit and return to the Main menu.

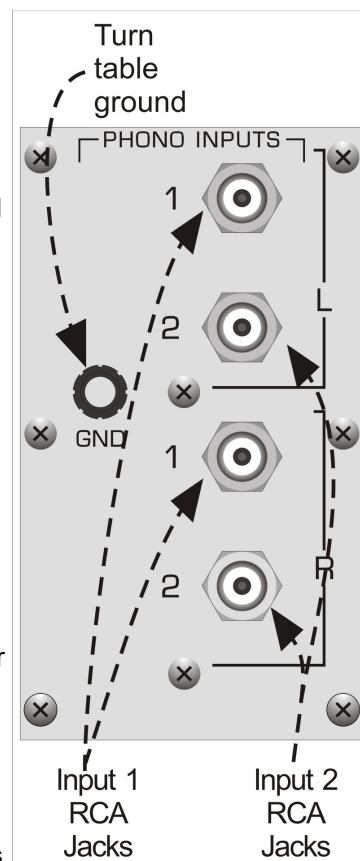
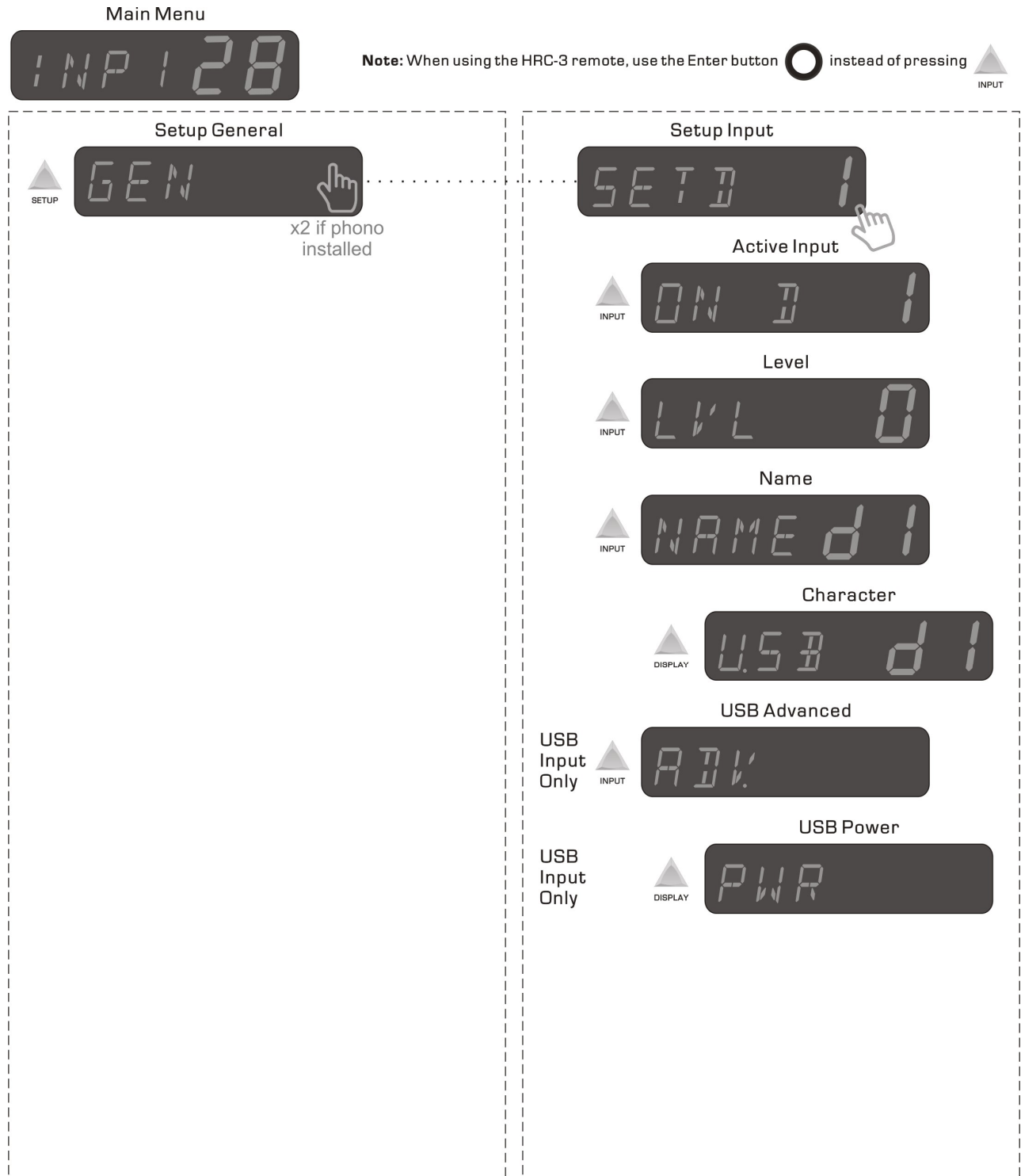

Figure 6 – Phono Module

Digital to Analog Converter (DAC)

When the optional DAC input module is installed, additional submenus will be revealed in the *Setup Input* section. The DAC submenus are shown below in the right-hand column.

The sample rate from an incoming signal is displayed.



Pertains to Mimas software version 1.79, DAC vers 1.05. Other versions may vary.

Rev. D1.00 2020-01-30

Figure 7 – Mimas DAC Menu Map



As indicated above, the USB Advanced submenus are available only when editing the D1, or USB input.

Setup DAC

There are 5 digital inputs on the DAC Module, one USB, 2 TosLink and 2 Coax RCA's. In the Setup DAC submenus, the USB is referred to as D1, D2 for the first TosLink, D3 for the second TosLink, D4 for the first Coax RCA and D5 for the second Coax RCA. Each of these 5 inputs can store unique settings. The USB input is capable of reading a 24bit / 352K, DSD & DSD2 digital signal and it utilizes Wavelength Technologies' asynchronous implementation.

To set the DAC inputs to their appropriate values, navigate to the DAC Setup submenu by pressing the SETUP button, then press the right side of the display lens to get to the Setup *Input* menu. Continue pressing the right side of the lens until the desired digital input (D1 through D5) is displayed.

Input Active

The factory default setting for all Digital Inputs ON.

From the Main menu, to set whether an Input is active or not, press the SETUP button. Press the left or right side of the display lens (UP/DOWN buttons on the remote) to select SETDx, where x = the input number to be edited, in this example, D1. Press the INPUT button (Enter on the remote) once. Press the left or right side of the Display (UP/DOWN buttons on the remote) to turn the Input On or Off. Press the SETUP button to exit and return to the Main menu.

Level

The factory default is 0.

Digital source material may have different levels. To streamline this, the Mimas allows the user to adjust any Input level to match that of other sources. The range is -12 to +12.

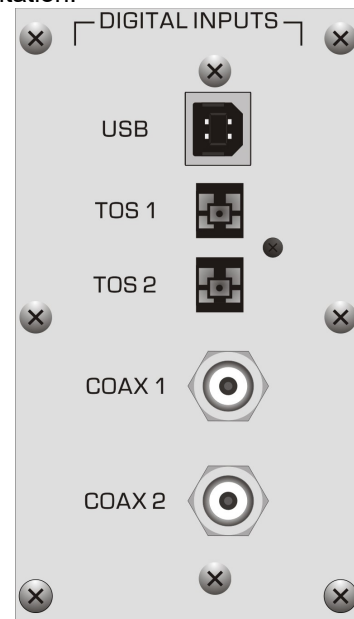

Figure 8 – DAC Module

To change the offset of Digital Input 1 (USB), from the Main menu press the SETUP button. Press the left or right side of the display lens to select SETD1. Press the INPUT button twice so that the display reads **LVL**. Use the left or right side of the display lens (UP/DOWN buttons on the remote) to select the desired value. If the source is playing, the user will hear the audio level change as the displayed value does. Press the SETUP button to exit and return to the Main menu.

Digital Input Name

Unlike the Analog input names, the factory default names for the digital inputs are described by their connection type: USB, TOS1, TOS2, Cox1 and Cox2. (D1 through D5 respectively).

Each input can be named using up to four characters. The available characters are A-Z; [blank]; 0-9 and several special characters.

To name an Input, from the Main menu press the SETUP button. Press the left or right side of the display lens (Left/Right arrow on the remote) to select SETD 1, or the desired digital Input to name. Press the INPUT button (Enter on the remote) three times so that the display reads NAME. The right side of the display will indicate D1 through D5 based on the selected input to edit. Press the DISPLAY button once. The current name is displayed. Use the left or right side of the display lens (or Up/Down button on the remote) to select the desired character. Press the DISPLAY button to move to the next character, which is identified with a dot to the right of it. Repeat to edit each character. Press the SETUP button to exit and return to the Main menu.

Advanced (USB / D1 Input Only)

When editing D1 (The USB input), there is an "ADV" (advanced) menu that allows the user to tell the Mimas DAC module to retain power at the USB input even when the Mimas Input is switched to SPDIF or analog. This will allow the computer to continue to stream the file without overrunning its buffer. This menu and feature are available in the Mimas only when the DAC board is installed.

To access this sub menu, from the Main menu press the SETUP button. Press the left or right side of the display lens (Left/Right arrow on the remote) to select SETD 1. Press the INPUT button (Enter on the remote) four times so that the display reads ADV. Press the DISPLAY button once. The display will flash either "PWR KEEP ON" (when a non-USB input is selected) or "PWR ONLY WHEN SEL". Use the left or right side of the display lens (Up/Down button on the remote) to select the desired behavior. Press the SETUP button to exit and return to the Main menu.

Appendix A Internal Gain Jumper Settings



Caution: to reduce the risk of electrical shock, do not remove any of the cover panels.

No user-serviceable parts inside. Refer all servicing to qualified service personnel only.

Changes to these settings must be completed by an authorized service technician, and the unit must have its AC cord removed for at least 15 minutes prior to removing the top cover. Contact your dealer if these settings need to be adjusted.

Internal Gain Jumper Settings

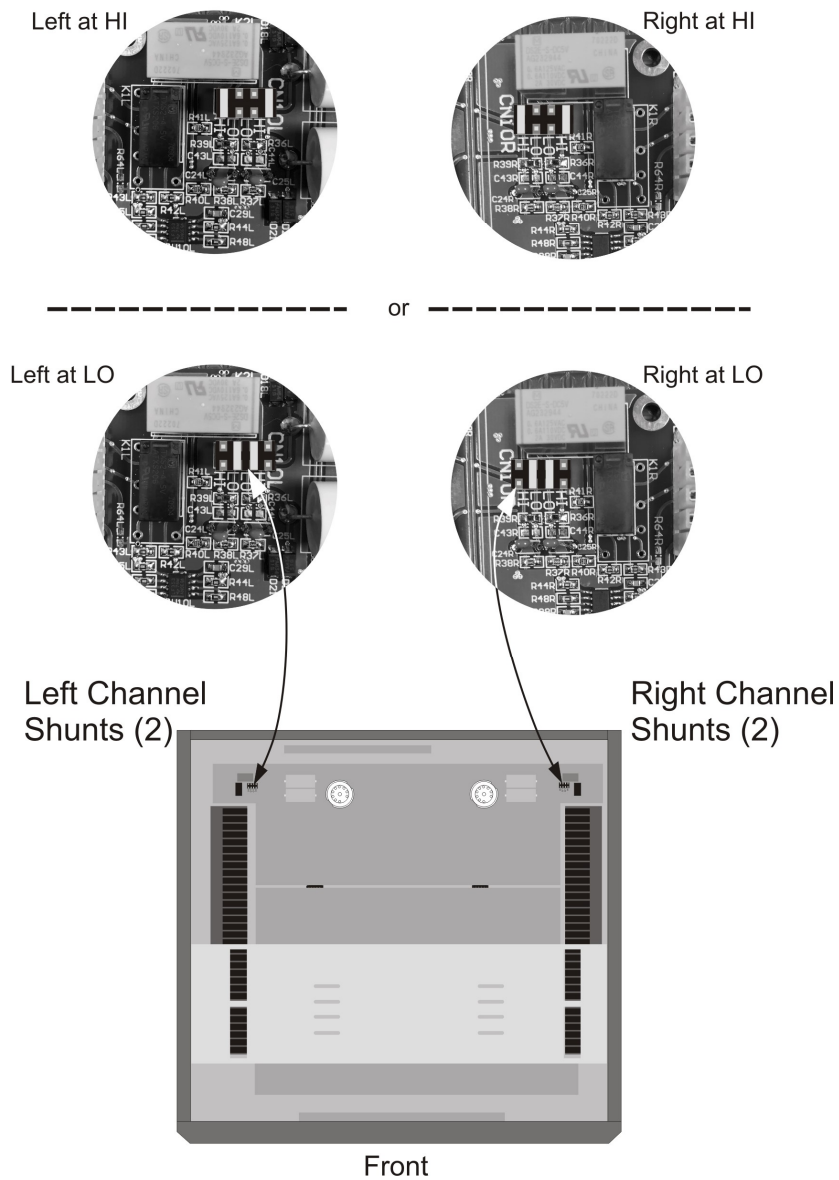

Figure 9 – Internal Gain Jumper Settings

Appendix B Troubleshooting & Maintenance Guide

If the Mimas should function abnormally during operation, please review the items in the following checklist. Please be sure to thoroughly check all other connected components such as speakers as well as cables.

Symptom	Possible Cause(s)	Remedy
No power or front panel lights and no sound.	Power cable is not inserted 100% into AC input connector.	Ensure that the AC cord is inserted all the way into the Mimas and that the wall outlet is active.
	Power Supply fuse is open.	Replace with same type and rating ONLY.
	Rear panel fuse is open.	Replace with same type and rating ONLY.
	Circuit breaker is open (AC outlet).	Check the AC outlet circuit breaker and reset, if necessary, or contact your dealer.
	Module rail fuse is open.	See "Display codes" section below.
Display turns off seconds after coming out of Standby.	Display is turned off.	Once the Mimas comes out of Standby and the display turns off, press the Display button once. It will now stay on.
Not responding to HRC-3 remote.	Mimas IR set to Calypso.	In Setup: IR, change setting to Metis.
	Remote mis-programmed.	Restore factory settings on remote.
No audio output.	Headphones are connected and turned off.	In the Setup Menu, set the headphones (HP) to ON.
	Mute is active.	Un-mute the Mimas.
	Overheating.	The amp module(s) may be overheated. Shut down the Mimas until it cools. An external fan may be necessary.
	Amp module fuse is open.	Replace with same type and rating ONLY.
Input missing in display	Input turned off.	Turn on input in Setup/Inp.
Hot/Warm	Normal operation	
Remote flashes 5 times when any one button is pressed.	Battery is too low to operate.	Replace HRC-3 battery with same type. Dispose of old one per the regulations of your local district.

Display Codes

If the Mimas displays the following message in the display upon power up:

LEFT FUSE PLUS The left channel plus fuse is blown. Replace with same type and value.
 LEFT FUSE NEG The left channel minus fuse is blown. Replace with same type and value.
 RITE FUSE PLUS The right channel plus fuse is blown. Replace with same type and value.
 RITE FUSE NEG The right channel minus fuse is blown. Replace with same type and value.

HOT Heatsink Temperature over 85 C. Turn Mimas off to cool it. Research reason for overheating.
 (DC) DC offset on the output.

If one of these messages is in the display on power up, the Mimas will not come out of STANDBY until the error is corrected.

Maintenance

	<p>Warning: Do not, under any condition, remove the top cover while the AC power cord is connected to the unit. Since the power supply remains charged even with power removed, wait <u>at least</u> 15 minutes after removing the AC power cord before attempting any maintenance. <u>Not doing this will result in damage, not covered under warranty.</u></p>
---	--

Under normal conditions, internal access is not required. In the event of a noisy tube or other maintenance, the top cover may be removed. There are 2 screws to be removed at the top of the rear panel, which is securely held in place by an advanced polymer interlocking material. To remove the top cover, after removing the 2 rear panel screws, grasp it at the rear left edge and pull up firmly. The interlocking material will gradually disengage as the top cover is "peeled" up.

To reinstall the top cover, align the front edge with the back of the faceplate and gradually press down, starting at the front and moving toward the back. Then secure it with the 2 screws.

Appendix C RS232 Pinout

RS232 Hardware Connections

RTS and CTS are not implemented the Mimas

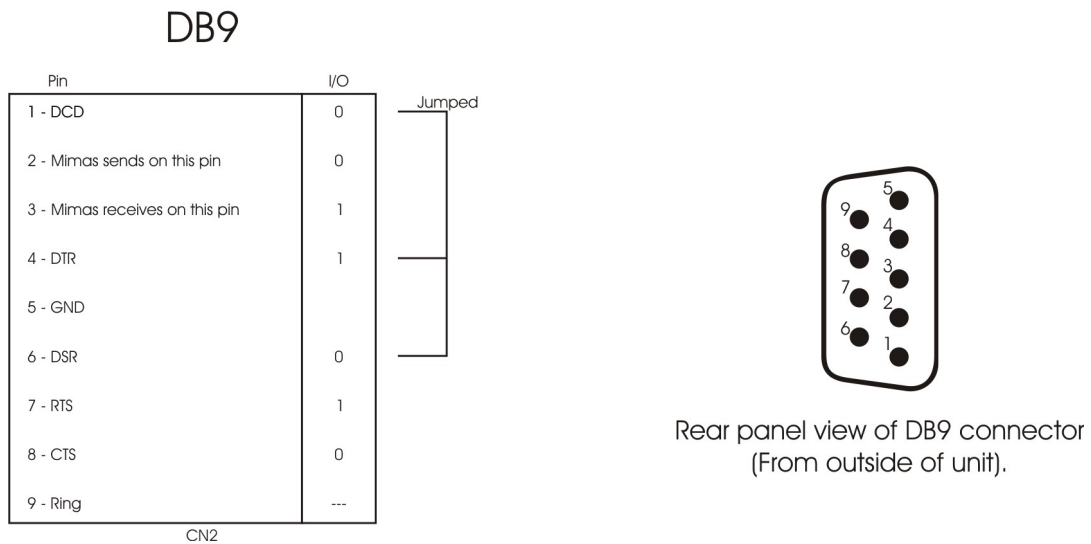

Figure 10 – Mimas RS232 Jack Pinout

These are the connector drawings only. The RS232 cable must be a regular RS232 or mouse extender cable, wired pin for pin.

The RS 232 Protocol data is available upon request.

Appendix D Specifications

- Inputs:** Analog Line Connectors:
1 single-ended RCA and 1 Balanced XLR for each of the 5 analog Line Inputs.
Input Impedance: 20K Ω Single-ended or 40K Ω Balanced (20K per phase).
Gain: (Tube variable) Preamp: 24dB maximum w/gain jumpers @ 0dB.
Power amp: 26dB.
Polarity: (Balanced) Pin-2 = Positive, Pin-3 = Negative.
Maximum input level: 9V RMS per phase
- Phono (optional):
1 single-ended RCA per channel for 2 Phono inputs.
Resistive & capacitance Load as well as Gain control. Ranges variable when MC or MM is selected.
Fully discrete FET-based, high gain differential circuit.
- Digital (Optional):
2 x RCA S/PDIF, 2 x TosLink S/PDIF & 1 x USB 24bit / 352K, DSD & DSD2. USB utilizes Wavelength Technologies' asynchronous implementation.
- Outputs:** Speaker:
Connectors: 1 balanced bridge output per channel. (See *Power Output* below).
Impedance: 0.25 ohms @ 1KHz.
Preamp Out:
Connectors: 1 balanced and 1 single-ended per channel. Both unfiltered.
Impedance: Single-Ended - 100 ohms; Balanced - 200 ohms (100 ohms per phase).
Headphone: 1/4" standard headphone stereo jack. 1/3W into 32 ohms, IC based.
HD (Optional): 1W into 32 ohms, fully discrete Class A with Mogami wiring.
- Modes/Processes:** Standby; Auto sense headphone & trigger; Home Theater Bypass available to each analog line input; Individual analog input level control; Internal Hi/Lo gain jumpers; Optional adjustable high pass filter installable on Output modules.
- Volume Control:** 88 1dB steps, utilizing individual switched 1% metal film resistors.
- Tubes** (2) - One 6922 (6DJ8) or equivalent per channel.
- Crossover:** (Optional) High pass 60Hz, 80Hz, 100Hz or 120Hz, hardware adjustable. All slopes are 6dB.
- Power Output:** (8 ohms) 150 W (rated) 185 W (typical).
(4 ohms) Nearly double.
- Frequency Response:** (-3dB points @ full power) 4 - 150 kHz.
- THD+Noise:** <1.0% (both channels driven at 150W into 8 ohms).
- Control:** RS232: 1 DB9 connector.
IR extender 1/8" stereo jack.
- Trigger Input:** 1/8" Jack, +5 and +12V auto sense Level or Pulse (> 100mS: Level; <100mS: Pulse).
- Power Consumption:** Active (no signal): 210W; Standby (normal mode): 100W; Standby (high efficiency mode): 6W.
- Dimensions:** 17 7/8" W x 17" 11/16" D x 5 5/8" H (43.4 x 44.9 x 14.3 cm).
Boxed: 24" x 24" x 12" (61 x 61 x 31 cm).
- Weight:** 42 Lbs. Standalone (19.1 Kg), 54 Lbs boxed with accessories (24.5 Kg).
- Maximum Operating Temperature:** Internal: 176° F (80° C).
Room: 122° F (50° C).
- Fuses: (All 5 x 20mm)** Mains: 10A SB @100, 117VAC. 5A SB @230, 245VAC.
Relay board: 1/2A SB @100, 117V AC. 1/4A SB @230, 245VAC.
Audio Outputs: 10A FB (Must be fast Blow).

Specifications subject to improvement or change without notice.

Appendix E Warranty

90 DAY LIMITED WARRANTY TERMS AND CONDITIONS

(3 Year optional extended service contract)

1. Aesthetix warrants the product designated herein to be free of manufacturing defects in material and workmanship, subject to the conditions herein set forth, for a period of 90 days from the date of purchase by the original purchaser. If the purchaser registers the unit with Aesthetix by mailing in the warranty card, together with a copy of the bill of sale, within 14 days of the date of purchase, said purchaser will be registered for an extended service contract. The extended service contract extends the 90 days to a period of 3 years from the date of purchase by the original purchaser or no later than 4 years from the date of shipment to the authorized Aesthetix dealer, whichever comes first. The warranty period for factory tubes does not get extended and therefore remains at 90 days.
2. **CONDITIONS**

This warranty is subject to the following conditions and limitations. The warranty is void and inapplicable if the product has been used or handled other than in accordance with the instructions in the owner's manual, abused or misused, damaged by accident or neglect or in being transported, or the defect is due to the product being repaired or tampered with or modified by anyone other than Aesthetix. The product must be packed and returned to Aesthetix by the customer at his or her sole expense. A returned product must be accompanied by a written description of the defect and a photocopy of the original purchase receipt. This receipt must clearly list model and serial number, the date of purchase, the name and address of the purchaser and authorized dealer and the purchase price. Aesthetix reserves the right to modify the design of any product without obligation to purchasers of previously manufactured products and to change the prices or specifications of any product without notice or obligation to any person.
3. **REMEDY**

In the event the above product fails to meet the warranty, and the above conditions have been met, the purchaser's sole remedy under the limited warranty shall be to return the product to Aesthetix where the defect will be rectified without charge for parts or labor.
4. **LIMITED TO ORIGINAL PURCHASER**

This warranty is for the sole benefit of the original purchaser of the covered product and shall not be transferred to a subsequent purchaser of the product.
5. **DURATION OF WARRANTY**

This warranty expires 90 days after the date of original purchase. If Aesthetix receives the warranty registration card, this period is extended to the third anniversary of the date of purchase or no later than the fourth anniversary of the shipment to the authorized Aesthetix dealer, whichever comes first. The warranty period for factory tubes does not get extended and therefore remains at 90 days.
6. **MISCELLANEOUS**

ANY IMPLIED WARRANTIES RELATING TO THE ABOVE PRODUCT SHALL BE LIMITED TO THE DURATION OF THIS WARRANTY. THE WARRANTY DOES NOT EXTEND TO ANY INCIDENTAL OR CONSEQUENTIAL COSTS OR DAMAGES TO THE PURCHASER. Some states do not allow limitations on how long an implied warranty lasts or an exclusion or limitation of incidental or consequential damages, so the above limitations or exclusions may not apply to you. This Warranty gives you specific legal rights, and you may also have other rights, which vary from state to state.
7. **WARRANTY OUTSIDE THE USA**

Aesthetix has formal distribution in many of the countries of the free world. In each country the Aesthetix importer has contractually accepted the responsibility for product warranty. Warranty should normally be obtained from the importing dealer or distributor from whom you obtain your product.